

THE PROPERTY OF THE DRAWING IS ESTABLISHED BY LAW. IT IS FORBIDDEN TO PRODUCE OR SHOW IT TO THIRD PART. WITHOUT A WRITTEN AGREEMENT.

Item	Name	Q.ty
1	CA.08.03.005	1
2	CA.08.09.004	1

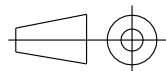
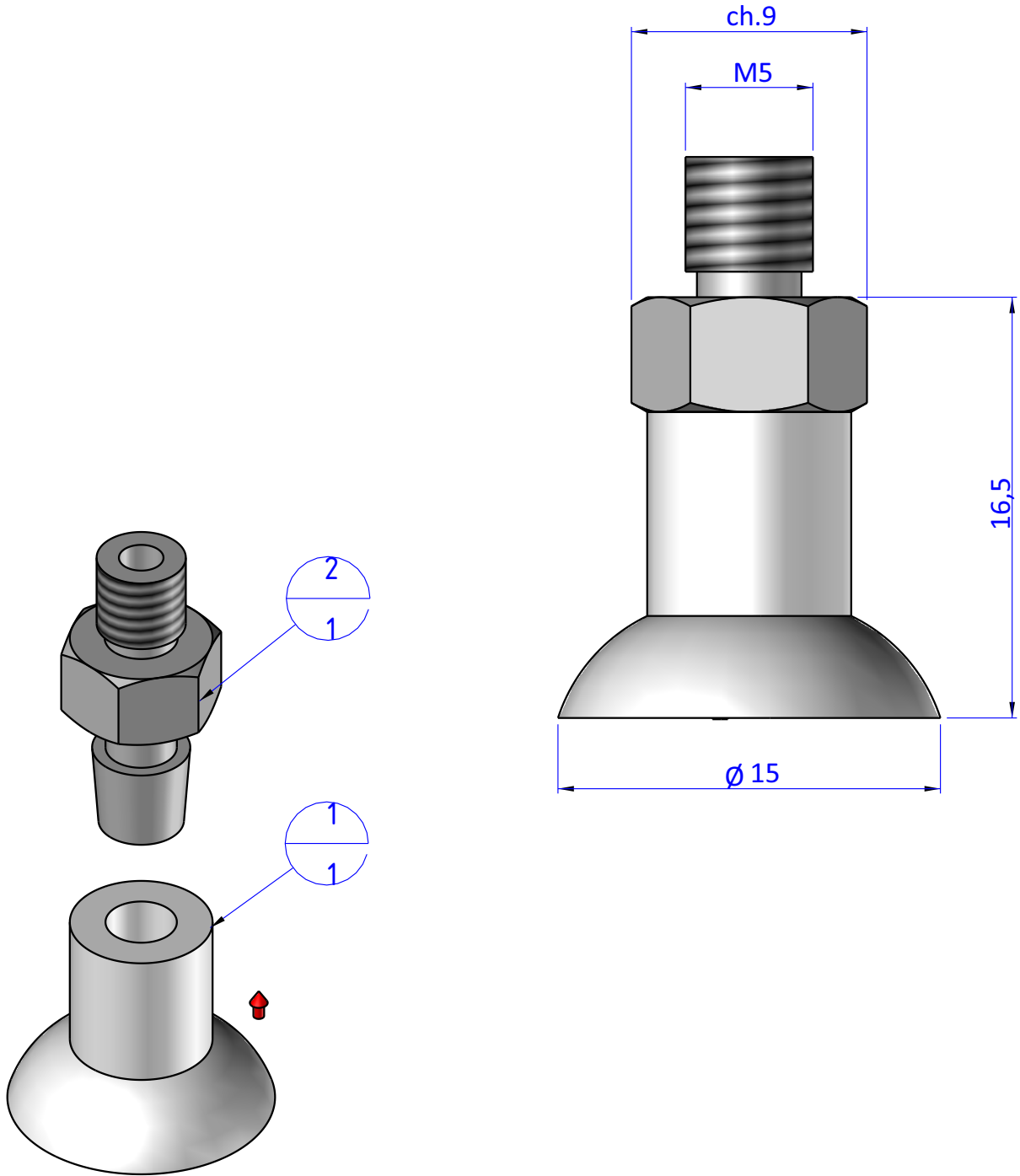

DESIGNED FROM FPS Automation		REVIEW A
DATE 04/11/2020	WEIGHT 0,002kg	
CODE KIT.08.03.D15.4		

Format **A4**

UNI 936-76

GENERAL TOLERANCE

UNI - ISO 2768

CLASSE **f**

DESCRIPTION

KIT.08.03.D15.4